

## CORGI ERCO H3202 SERIES - 2 POST LIFTS

- Electrohydraulic two-post lifts with 3-stage and extra-flat symmetrical arms.
- The H3202 range lifts are operated by a master/slave type hydraulic circuit with automatic realignment of the two trolleys at each lifting cycle; thanks to this circuit, the H3202 range lifts are particularly reliable, easy to install and do not require mechanical adjustments after the first installation (there are no metal ropes between the columns).
- Automatic braking exclusion button. This function makes it possible to lower the lift without the initial upward step.

Max. capacity	3200 kg
Lifting time	30 s
Lowering time	34 s
Electric motor power	2.6 (400V 3ph 50Hz)
Power supply	230-400V 3ph 50-60Hz
Control circuit tension	24 V



Ref. No.	Description	Content
<b>0-43102203/15</b>	CORGI ERCO H3202 V	1
<b>0-43102204/15</b>	CORGI ERCO H3202 CBP	1

**FROM:**  
**£22-23 PER WEEK\***

### ERCO H3202 V OVERHEAD PIPES

£2,750.00+VAT  
PROMOTION

**£22.23+VAT**  
PER WEEK. 3YR LEASE  
SUBJECT TO STATUS

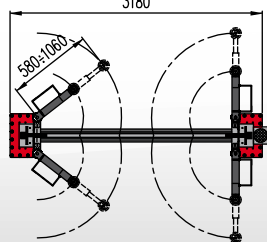
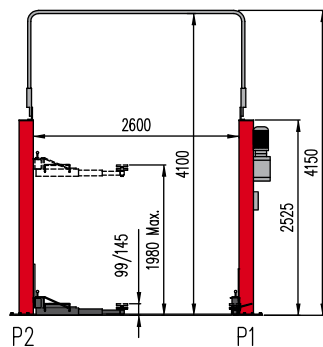

### ERCO H3202 CBP VERSION WITH BASE

£2,950.00+VAT  
PROMOTION

**£23.85+VAT**  
PER WEEK. 3YR LEASE  
SUBJECT TO STATUS

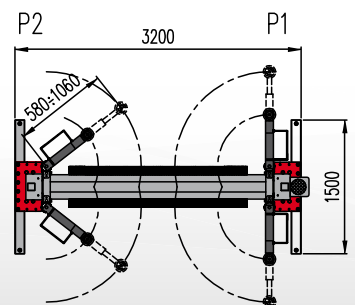
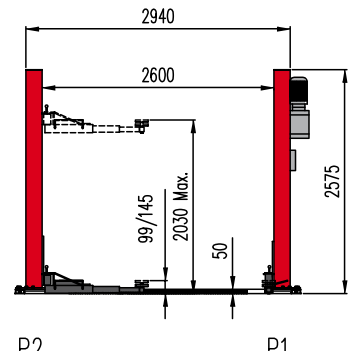

\*ALL PRICES SUBJECT TO VAT, DELIVERY AND INSTALLATION.

\*LEASE PRICES ARE SUBJECT TO STATUS AND VAT. PRICES PER WEEK, 3 YEAR LEASE.



FINANCE OPTIONS ✕ SERVICE CONTRACTS 7 ACCESSORIES 2 YEAR WARRANTY 🚚 DELIVERY AND INSTALLATION



**0113 2770044**  
WWW.REMA-TIPTOP.CO.UK



# CORGI LIFTS SUMMER SALE LIMITED STOCK

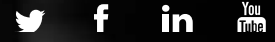

## CORGI ERCO 4004 SERIES - 4 POST LIFT

- Special solutions have been used to create lifts with a maximum load capacity of 4000 kg together with a minimum ground height of just 126mm.
- The lifts with wheel alignment have large runways that make it possible to lift most vehicles without having to frequently adjust the mobile runway. The 2,950 mm spacing between the posts ensures complete compatibility with 3D wheel aligners.
- The four column lifts series "ERCO4004-5004" are electrohydraulically operated.
- Safety devices directly activated by 4 electromagnets which increase the operation speed and safety.
- Better utilisation of the internal spaces, reduced overall dimensions, four independent cables.
- All devices prescribed by the CE norms and existing regulations.



**ERCO 4004 WCT**  
WHEEL ALIGNMENT RUNWAYS

Max. load	4000 - 5000 kg
Lifting/lowering time	40/40 s
Pneumatic power supply	4 - 10 bar
Motor power	2.6 (400V 3ph 50Hz)
Power supply	230-400V 3ph 50-60Hz
Max. capacity	3500 kg

Ref. No.	Description	Content
<b>0-43103701/15</b>	CORGI ERCO 4004WCT	1

**FROM:**  
**£42.45 PER WEEK\***

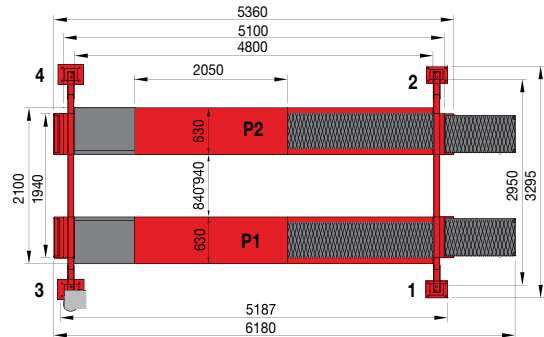
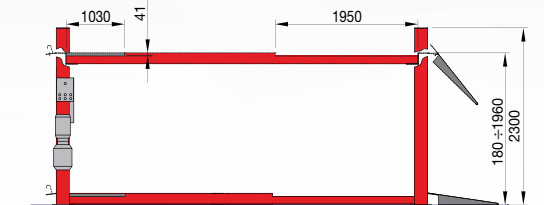

## ERCO 4004 WCT

£5,250.00+VAT  
PROMOTION

**£42.45+VAT**  
**PER WEEK. 3YR LEASE**  
SUBJECT TO STATUS

\*ALL PRICES SUBJECT TO VAT, DELIVERY AND INSTALLATION.

\*LEASE PRICES ARE SUBJECT TO STATUS AND VAT. PRICES PER WEEK, 3 YEAR LEASE.



FINANCE OPTIONS ✕ SERVICE CONTRACTS 7 ACCESSORIES 🛡️ 2 YEAR WARRANTY 🚚 DELIVERY AND INSTALLATION



exclusively distributed by REMA TIP TOP in Great Britain

**0113 2770044**  
**WWW.REMA-TIPTOP.CO.UK**



# CORGI DEALS SUMMER SALE LIMITED STOCK

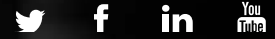

## £36.<sup>38</sup> PER WEEK\*

CORGI MOBILE TYRE FITTING SOLUTION + FREE INSTALLATION



TYRE CHANGER	BALANCER	PROMO PRICE	LEASE PRICE
PROLINE 122N +SX1 ASSIST ARM	EM43 TILT	£4,500.00+VAT	£36.38+VAT

## £54.<sup>58</sup> PER WEEK\*

CORGI EXACT 7 ALIGNER + FREE INSTALLATION

PRECISE, RELIABLE WHEEL ALIGNER FOR PASSENGER CARS AND LIGHT TRANSPORT VEHICLES.

- WHEELED UNIT
- 4 RADIO MEASURING SENSORS WITH BATTERIES AND CHARGING SYSTEM
- RADIO MODULE FOR CENTRAL UNIT AND HARDLOCK
- PC WITH MULTILINGUAL WINDOWS OPERATING SYSTEM • STEERING LOCK AND PEDAL PRESSER
- DVD WITH SOFTWARE AND USER MANUAL



£54.58+VAT PER WEEK. 3YR LEASE  
SUBJECT TO STATUS

£6,750.00+VAT PROMOTION

## £66.<sup>70</sup> PER WEEK\*

CORGI EXACT LINEAR ALIGNER + FREE INSTALLATION



THE EXACT LINEAR'S EVOLUTION HAS BEEN SIGNIFICANT WITH THE INTRODUCTION OF NEXT GENERATION CAMERAS EQUIPPED WITH HIGH RESOLUTION HIQ LENSES.

USER FRIENDLY GRAPHICS AND ICON BASED EXACT SOFTWARE IS EASY TO LEARN AND FAST TO SELECT. SOFTWARE ALLOWS SELECTABLE PRINTOUT IN COLOUR OR BLACK AND WHITE GRAPHICS ONLY. LIVE ADJUSTMENT, ALL ANGLE VALUES INDICATED IN REAL TIME.

FOR EARLY GUIDANCE THERE IS ALSO A SELECTABLE ONLINE TUTOR TO GUIDE YOU THROUGH, STEP-BY-STEP, WITH GRAPHIC INDICATOR ON HOW TO PROCEED.

£8,250.00+VAT PROMOTION

£66.70+VAT PER WEEK. 3YR LEASE  
SUBJECT TO STATUS



## £104.<sup>10</sup> PER WEEK\*

ELECTRO-HYDRAULIC LIFT + CORGI EXACT 7 - WHEEL ALIGNMENT MACHINE



### PACKAGE DEALS

4 POST LIFT	ALIGNER	PROMO PRICE	LEASE PRICE
ERCO 4004W CT	EXACT 7	£12,875.00+VAT	£104.10+VAT
ERCO 4004W CT	EXACT LINEAR	£13,700.00+VAT	£110.77+VAT

\*ALL PRICES SUBJECT TO VAT

\*LEASE PRICES ARE SUBJECT TO STATUS AND VAT. PRICES PER WEEK, 3 YEAR LEASE.

EXCLUSIVE

RECOMMENDED AT POINT OF USE  
REMOVES 99.9999% WATER



£195.00+VAT

2018 NTDI INNOVATION WINNER



FINANCE OPTIONS ✕ SERVICE CONTRACTS ✕ ACCESSORIES ✕ 2 YEAR WARRANTY ✕ DELIVERY AND INSTALLATION



exclusively distributed by REMA TIP TOP in Great Britain

# 0113 2770044

WWW.REMA-TIPTOP.CO.UK